

Franke Innovative

The Magazine

Issue 10

www.franke-innovativ.de/en

10

Innovation in Motion

Cover Story: Wire Race Bearings for Exoskeletons

Super Individual

Special Bearings
Sustainability

New Products

Bearing Element LER1.5
Rotary Systems LTD
Linear Guides FDI

The High-Tech-Tinkerers

Manufacturing at Franke

Applications

Innovation in Motion!

The **Ivanpah Solar Electric Generating System** is a solar thermal power plant in the Mojave Desert in northeastern San Bernardino County, California. With a nominal capacity of 392 MW, it was the world's largest solar thermal power plant at the beginning of 2014.

Ecological _ Clean _ Innovative

173,500 mirrors follow the path of the sun and collect the light. Moved by Franke Wire Race Bearings.





Sascha Eberhard, Daniel Groz // General Manager

The stages of development of our company logo. From the very beginning, the functional principle of the Wire Race Bearing has been visualized.



Franke & Heydrich KG



Franke & Heydrich KG



Dear Readers,

we hope you are doing well!

The Corona crisis is a great challenge for all of us. Rest assured that we have done our homework. Hygiene rules, mobile working and separate shifts enable us to maintain operations at 100%. Our customers are supplied in the usual way and our suppliers continue to receive orders. We are still your reliable partner and do everything to ensure that this will not change.

Today we present you with the new issue of our customer magazine Franke Innovative. There is a lot going on at Franke and we are happy to report about it - all under the motto „Innovation“.

Innovation in Thinking

For over 70 years, innovative thinking has been a cornerstone of our company. Innovation is not only required for our products, but also for topics such as digitalization, service or the customer approach. New online tools for comparing and designing products are the best examples of this. More on this from page 8.

Innovation in Development

Three new products can be found in our program. One of them is the Wire Race Bearing LER1.5 - our smallest bearing element so far. In an exciting user report we have summarized the range of applications for you. You will find it starting on page 14.

Innovation in Manufacturing

Digitization / Industry 4.0 – modern production companies face many challenges. On page 26 you can read about how we manage to reconcile everything and why the balancing act between hand-made and using high-tech machines is so important to Franke.

Innovation in Applications

It is always amazing how variable wire race bearings and linear systems from Franke can be used. Customers who have recognized the potential of this technology are able to build better products. Starting on page 32 we have collected examples for you.

We wish you an enjoyable reading & all the best!
Your Franke GmbH

Daniel Groz
General Manager

Sascha Eberhard
General Manager



01



Innovation in Thinking

8 Super Individual

How Franke Special Bearings adapt to the Customer's Application

10 Tools to help customize Wire Race Bearings

12 Sustainability in Mechanical Engineering



02



Innovation in Development

14 New Products

16 **Cover Story:** Bearing Element LER1.5 for Exoskeletons

20 New: Rotary Systems LTD with Torque Motor

24 New: Linear Guide FDI



03



Innovation in Manufacturing

26 Digital / Analog

28 Between handwork and high-tech

30 Digitilazation at Franke



04



Innovation in Applications

32 Applications Examples

34 High-speed Bearing for the assembly of Circuit Boards

36 E-Mobility: Winding Machine for Electric Motors

38 Newsflash





Michael Momesso // Head of Shipping & Logistics



01

Innovation in Thinking

Leave conventional ways of thinking behind when it comes to our wire race bearings. Think of something like a **configurator**. Think of **sustainability**.

Super Individual

Franke Wire Race Bearings adapt to Your Requirements

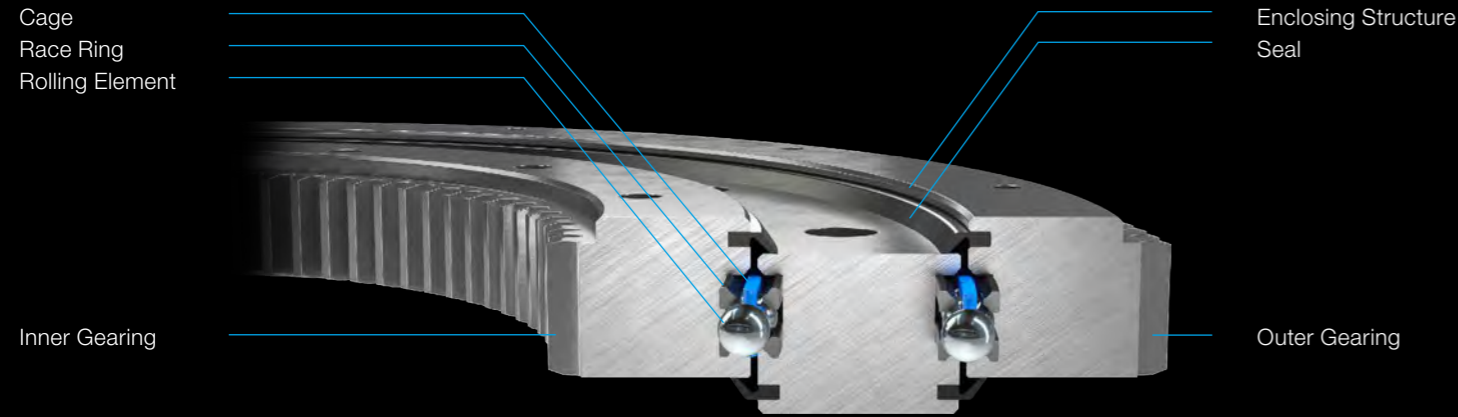

Rolling Elements



Standard Cages

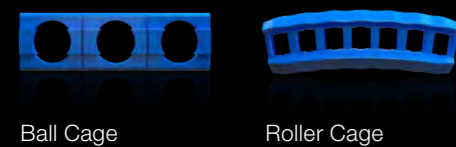

Gear

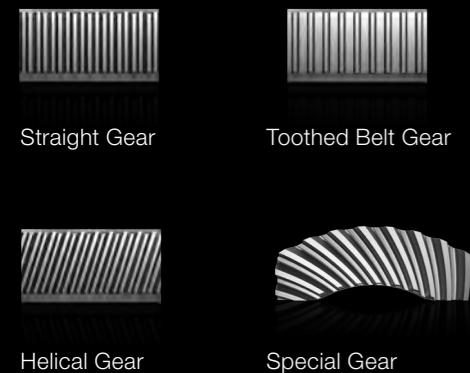

Race Rings

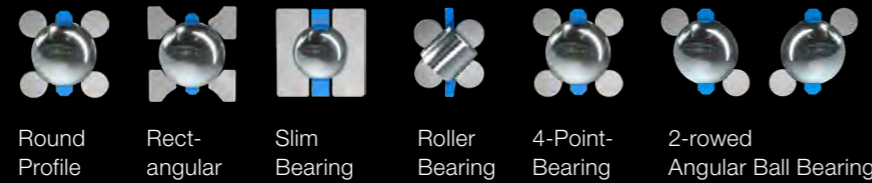

Special Versions

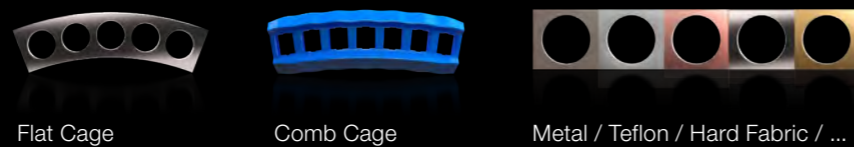

Enclosing Structure (Examples)

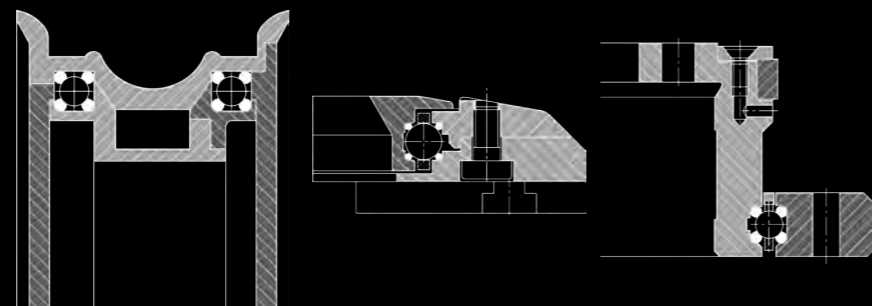

Free Choice of Design / Material / Sealing / Lubricant / ...

configure

Rolling Bearings re-invented: The Franke Modular System

The Franke modular system gives you an overview of the numerous possibilities of adaptation when using a Franke wire race bearing.

You are sure to find your special solution tailored to your application.

compare

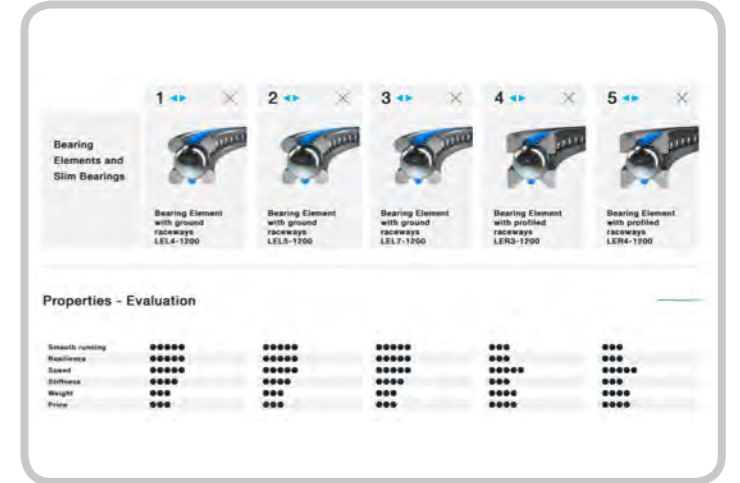

Compare products: Comparison tool

With the comparison tool you can see the key product features at a glance. The types of wire race bearings and linear systems can be compared quickly and easily. This gives you an overview of the most important values of the individual series, such as dimensions, load ratings or weight.

calculate

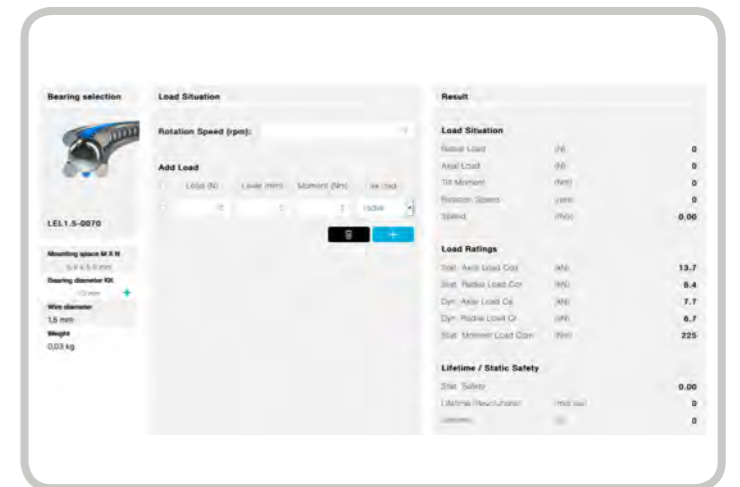

Calculate the load online: Calculation Tool

With the help of the calculation tool you can determine the expected service life online and make a preselection for your application. You can easily calculate the load case of the selected wire race bearing or linear system for the respective, individual application.



www.franke-gmbh.de

Learn more on our website

The Franke website is the best source of information about Franke products and about the company itself.

It provides further information about the Franke Modular System, the Comparison Tool and the Calculation Tool. The menu allows you to navigate through the website easily and intuitively. Detailed information on all products is supported by numerous application examples.

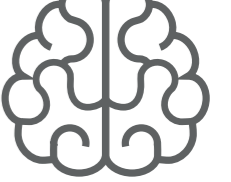



Sustainability in Mechanical Engineering

Franke Bearing Assemblies can be refurbished

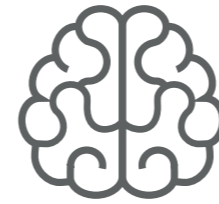

„Even with a bearing assembly from our standard program, refurbishing can be up to **60%** cheaper than a new purchase. With special solutions, the effect is even bigger.



Stephan Kuhn // Head of Technical Sales

Save Costs & Resources with the Refurbishment of Wire Race Bearings

Sustainability and resource conservation are also important topics in mechanical engineering. Repairing machines and components instead of scrapping them is in many cases the better approach to maintain or even increase the efficiency and profitability of a production plant. Franke wire race bearings can help you do this.

Bearing assemblies with integrated wire race bearings have a long service life. But even if the wire race bearing has reached the end of its service life, the elaborately manufactured housing parts can still be used. They are not directly exposed to the stresses of the bearing and are therefore often still in good condition.

Up to 60% cheaper than purchasing a new bearing

Often it is sufficient to replace individual components such as raceways, rolling elements and cages to restore the bearing to full working order. This saves time and costs and is a valuable contribution to the conservation of resources and the protection of the environment.



The geometric properties of all Franke wire race bearings are stored in our archives. For many years in digital databases, previously in handwritten documentation. The technical specifications even of bearing assemblies from the late 80's of the last century can be used to replace the wire race bearing to be renewed one-to-one.



02

Innovation in Development

Collaborate with us and discover constructive freedom. Think about **smaller, directly driven**, or suitable for **extreme conditions**.

Muscle-Games

Wire Race Bearings for Innovative Exoskeletons

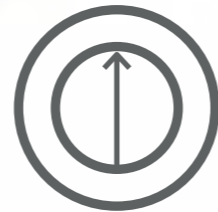
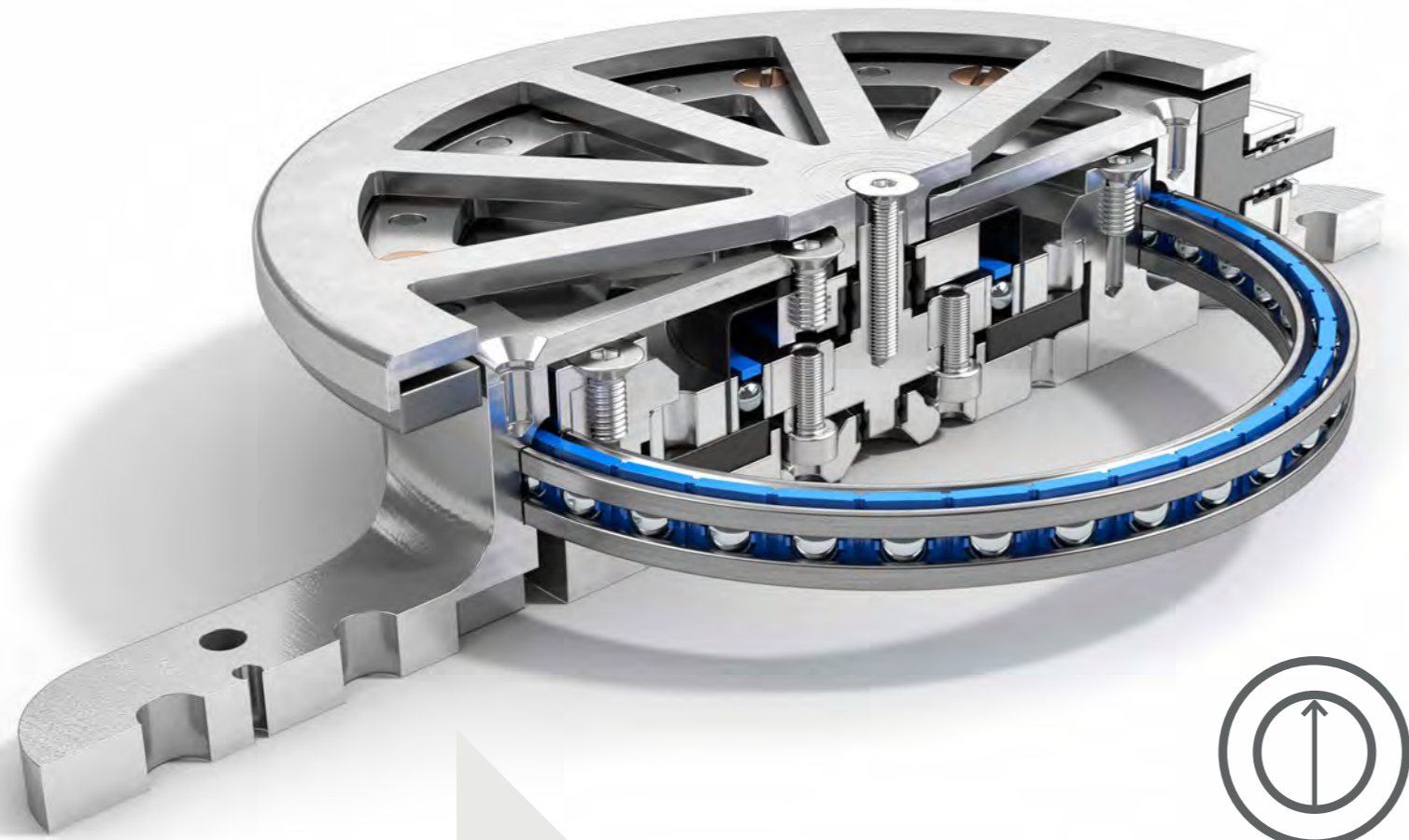

At a glance

Technical Data

Wire Race Bearing Type	LER1.5
Wire Race Bearing Diameter	70 mm
Total Joint Diameter	85 mm
Height of Wire Race Bearing	6,3 mm
Height of Joint	30 mm
Drive	Torque Motor
Torque	20 Nm
Power Consumption	60 Watt
Total Weight incl. Motor	238 g
Degree of Innovation	Very High



In the interview:
Johannes Wanner - M.Sc.
Department of Mechanical
and Materials Engineering
University of Aalen

Mr. Wanner, how did this research project come about?

Johannes Wanner: In view of demographic change and the increasing lack of skilled workers, it is a major challenge for the economy to keep employees as long and healthy as possible in the work process.

Explicitly, physically strenuous work that strains muscles, bones and joints must be considered here. Exoskeletons can help here. They are already used for heavy loads or unfavorable postures. Think of warehouse workers, painters, plasterers or assembly line workers.

Who are the people involved in the development?

Research institutes such as the TU Ilmenau or the University Hospital Jena support our work at Aalen University. Supporters of the project include Franke, companies from the orthopaedic technology sector and manufacturers of complex turned parts.

What is the challenge with the development?

The exoskeleton must not be perceived as irritating, the feeling of support must predominate. Since the „machine“ is attached directly to a human being, a good interaction must be created. The systems must complement each other. In addition, there are requirements regarding accuracy of fit, weight, safety and reliability. The system should be safe, robust and efficient. We need a lot of torque from little power. So far, there is nothing comparable on the market that actively supports people in various activities.

How can Franke wire race bearings support you?

Wire race bearings are very compact and lightweight. Especially the types of the LER series stand out. Simple mounting and adjustment of the preload are added. The center clearance of the bearing allows the gear unit to be centrally located. The large outer diameter ensures high rigidity.

What are the main criteria the joints have to meet?

The main criteria are stiffness, smoothness and load capacity. Low wear and tear is important, as well as smooth running and safety against damage, e.g. due to overloading.

How are the motors supplied with energy and controlled?

We calculate an energy requirement of 60 Watt per joint for 8 hours of use. This is easily achieved by modern rechargeable batteries. For stationary workplaces, a cable solution could even be considered. The sensors are controlled via the muscle. There should be no control buttons or similar.

The sensors detect the muscle movement and a control unit determines the necessary rotation of the motor. This increases the ease of operation, but also raises the demands on the response of the motors and the load behavior. Absolute freedom of play is a basic requirement for the system. This is where Franke wire race bearings score points over other solutions due to the adjustable preload.

What are the advantages over existing systems?

There is not much on the market yet. Most of them work with knob or lever control and are also not modularly adaptable to different activities. Our system can do that better.

What are your expectations for the future?

Exoskeletons will become lighter and cheaper. The most important thing is the acceptance. The more they are used, the lower the inhibition threshold will be. We would like to see a boom similar to that of the e-bike. There, the leap from rehab to sports equipment has been successfully made.

NEW: Bearing Element LER1.5

Welcome to the Family!

Miniaturization: The new LER1.5 enables bearing cross-sections of 5 x 6 mm.

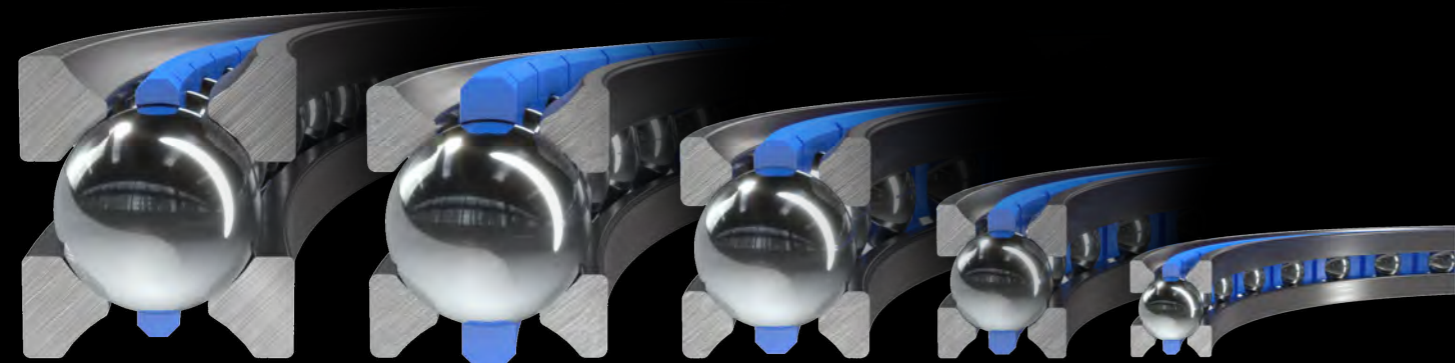

LER 5 15,75 x 17,5 mm

LER 4 14 x 16 mm

LER 3 11 x 13 mm

LER 2 7,5 x 8,9 mm

LER 1.5 5 x 6 mm



Franke Bearing Elements Type LER are suitable for medium rotational speeds and accuracies. They convince by smooth running, high dynamics and compact installation space. Due to the straight contact surfaces, they can be easily integrated into the mating structure and offer high rigidity.

The low price makes the bearing element of type LER a cost-effective solution. LER are usually mounted without clearance. The preload can be individually adjusted according to requirements.

The new LER1.5 series was specifically designed for use in ultra-compact applications such as human-robot collaboration or medical devices.

Scale 1:1

The new wire race bearing LER1.5 cross section 5x6 mm, rectangular profile available in diameters from 40-150mm

Your Contact:

Arne Jankowski
 Technical Sales
 Franke GmbH
 Tel. +49 7361 920-185
 a.jankowski@franke-gmbh.de



Construction Examples

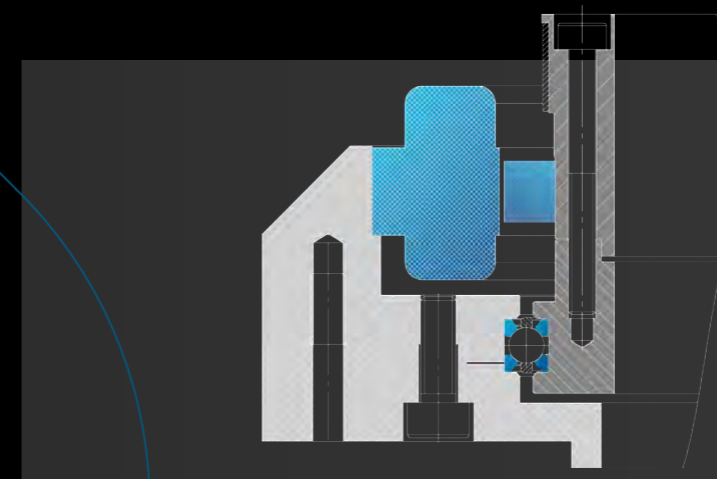

Construction Example 1

Franke Bearing Element Type LER with direct drive. The compact installation space allows extremely thin-walled constructions. The occurring load is completely compensated by the bearing element LER.

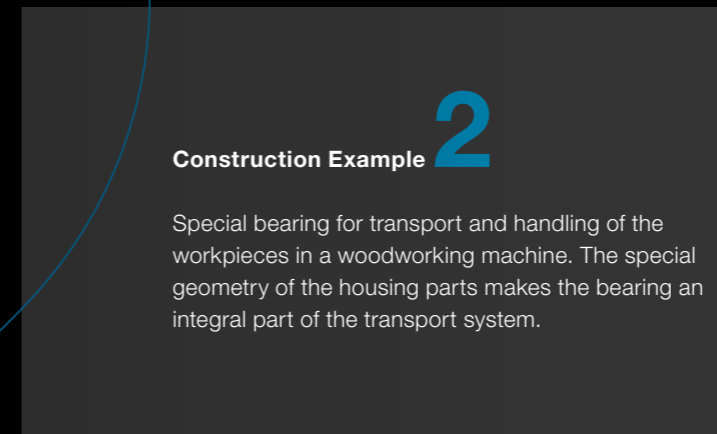

Construction Example 2

Special bearing for transport and handling of the workpieces in a woodworking machine. The special geometry of the housing parts makes the bearing an integral part of the transport system.

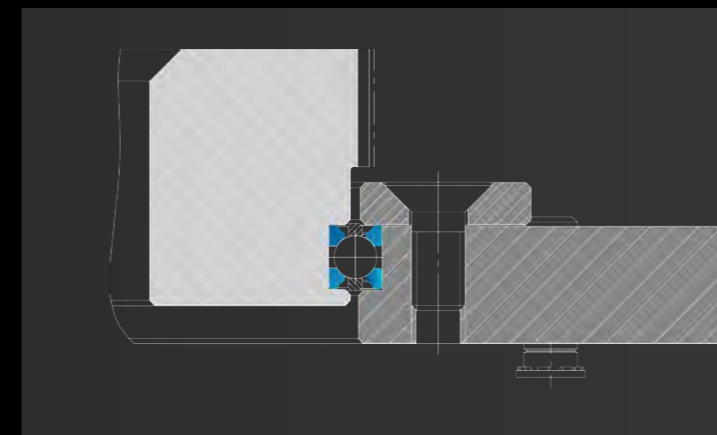

Construction Example 3

Direct integration of a LER 1.5 in a special bearing assembly with special toothing on the outer diameter of the inner ring.

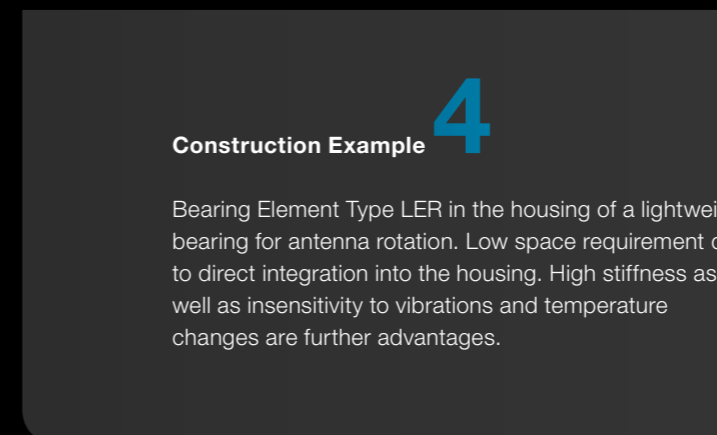

Construction Example 4

Bearing Element Type LER in the housing of a lightweight bearing for antenna rotation. Low space requirement due to direct integration into the housing. High stiffness as well as insensitivity to vibrations and temperature changes are further advantages.

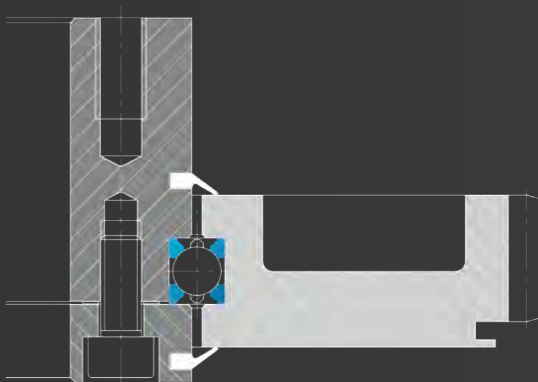

Bearing Assembly with Torque Motor Type LTD

Keep things moving - directly and completely!

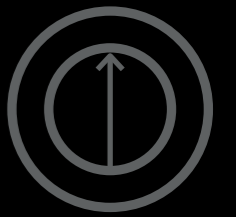

Franke **Rotary Tables Type LTD** with integrated direct drive are characterized by highest energy efficiency. The integration of the drive motor directly into the bearing makes it possible to dispense with components such as gears and drive pinions and thus with complex lubrication circuits. The moving masses are significantly lower, and power loss due to friction is minimized.

The standard series with four diameters from 100 to 385 mm is available from stock. For adaptation to your application, further diameters in the range of 60 to 2000 mm as well as special versions regarding material, motor power or electronics are available on request.

Your Benefit

- Integrated System
- High Dynamics, High Efficiency
- Customized Design Possible
- Motor, Measuring System and Controller freely selectable

Areas of Application

- Medical Technology
- Automotive Engineering
- Navigation / Antenna Systems
- Pick & Place
- Assembly
- Automation

At a glance

Technical Data

- Ready-to-install complete system
- Standard diameter KK 100, 215, 320, 385 mm
- Special diameters from 60 - 2000 mm on request
- 4-point bearing, preloaded free of play
- Housing parts available in steel or aluminum
- Integrated torque motor (potted)
- Motor monitoring using PTC thermistors and PT1000
- Max. torque 118 NM (for KKØ 385 mm)
- Max. speed 2.140 rpm (for KKØ 100 mm)
- Electrical connection via radial plug
- Incremental measuring system

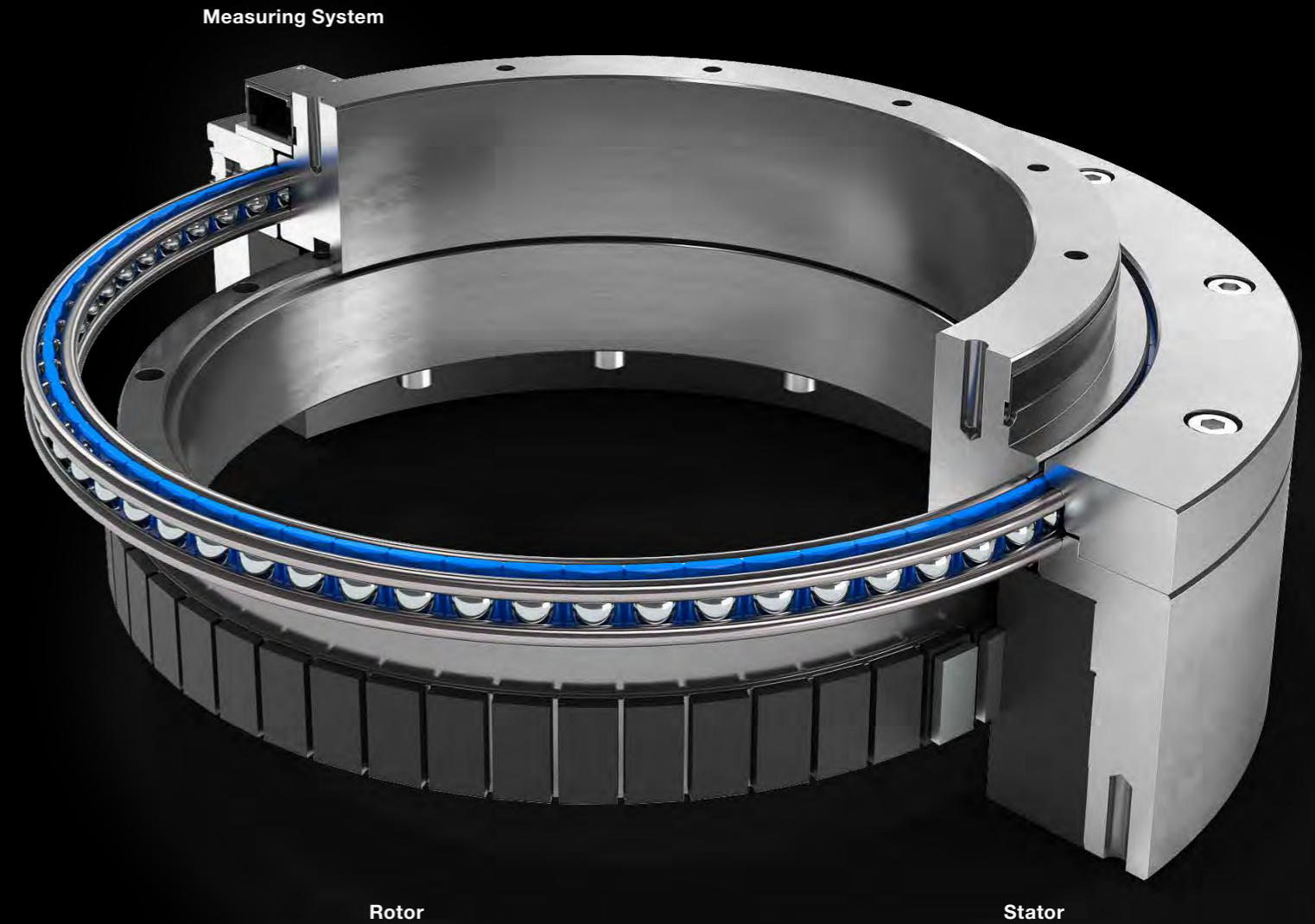

Your Contact:
 Peter Niemeyer
 Design/Technical Sales
 Franke GmbH
 Tel. +49 7361 920-172
 p.niemeyer@franke-gmbh.de



Application Example Rotary Table Type LTD

Thread Testing of Pipeline Pipes



Optical Measuring Methods: Contactless, Highly Accurate and Reproducible

End threads of pipeline pipes must meet tight dimensional tolerances for a permanent load-bearing connection between two pipes. High resolution optical measuring systems are used to measure compliance with these narrow tolerances.

In addition to the careful adjustment of the camera systems, the design of the inspection mechanics by means of high-precision motion components is of decisive importance for the result of the measurement. The use of Franke Bearing Assemblies with direct drive leads to a considerable improvement in quality when measuring threads.

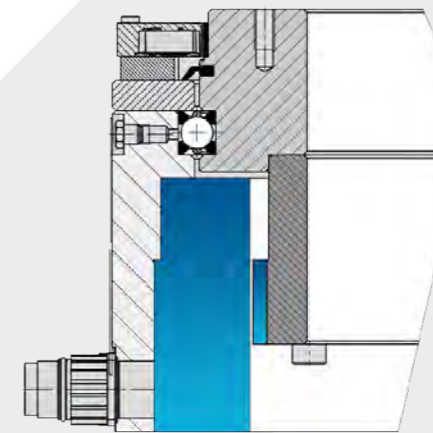
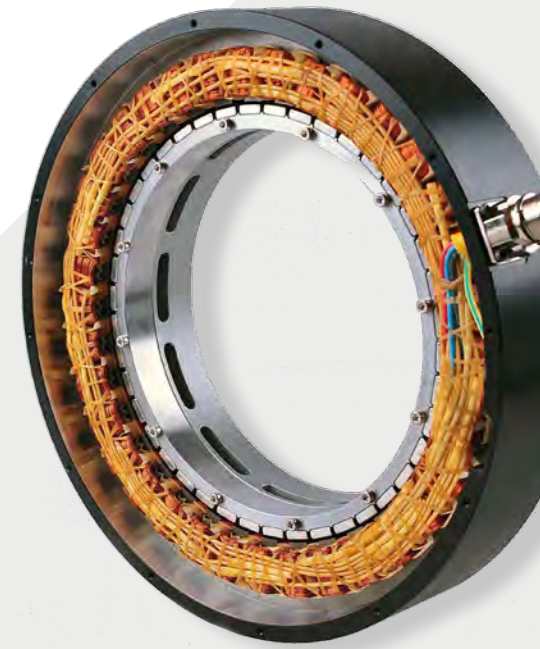

The Task

- Dynamic and high-precision testing process
- Special radial and axial run-out accuracy 0.02 mm
- Lightweight construction
- High positioning accuracy
- Preparation for existing SEW servo controller

The Solution

Franke Bearing Assembly with direct drive LTD-385-Z in special design

The Benefits

- Long service life, hardly any wearing parts
- Quiet, high dynamics
- Fast and exact positioning
- Anodized aluminum version
- Absolute measuring system with 2 measuring heads
- Temperature sensor as feedback signal

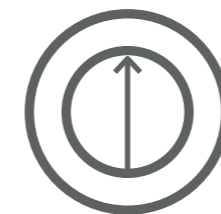

Vacuum-compatible

Linear Guides:
New Cassette Type FDI for Vacuum

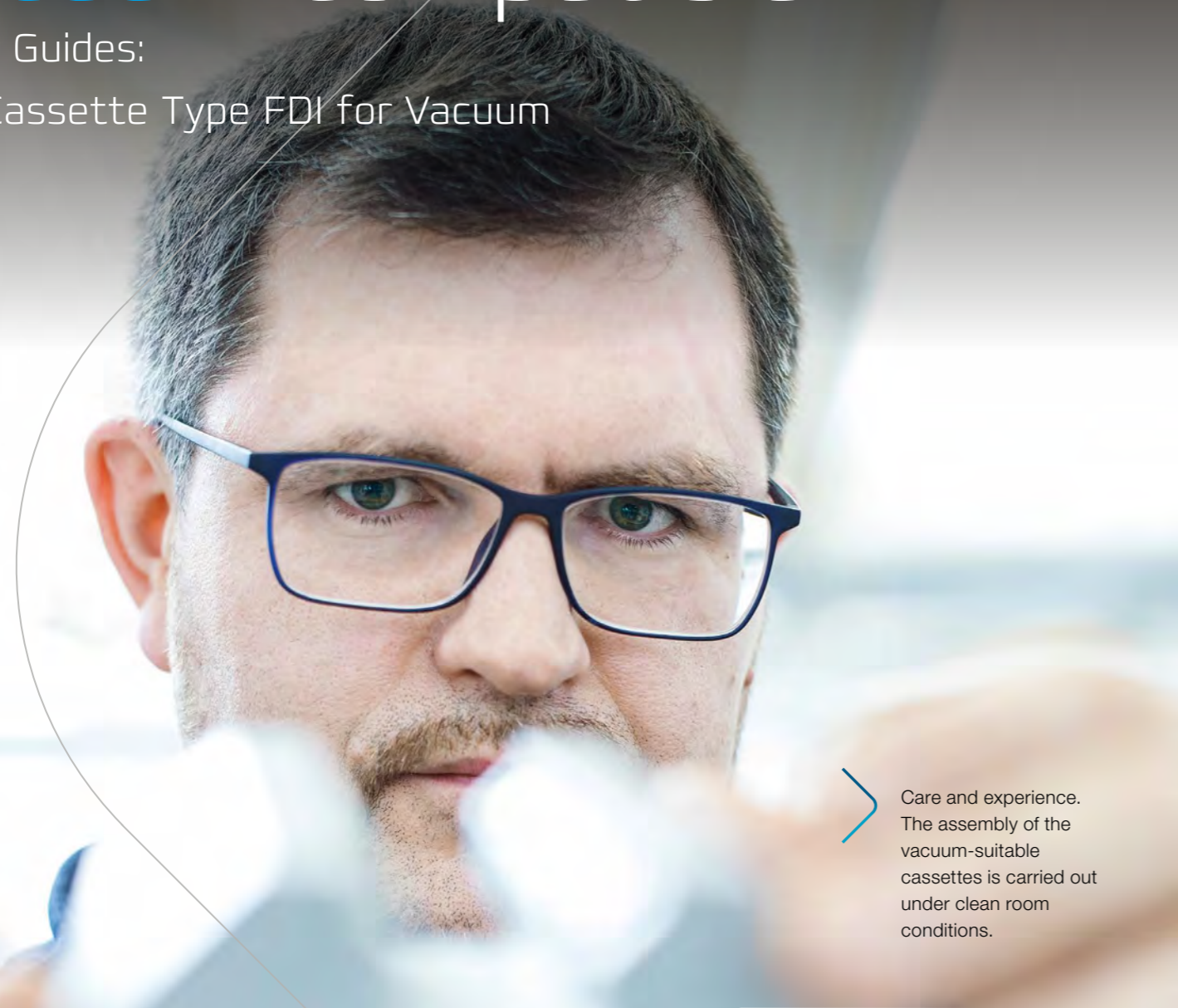

Care and experience. The assembly of the vacuum-suitable cassettes is carried out under clean room conditions.

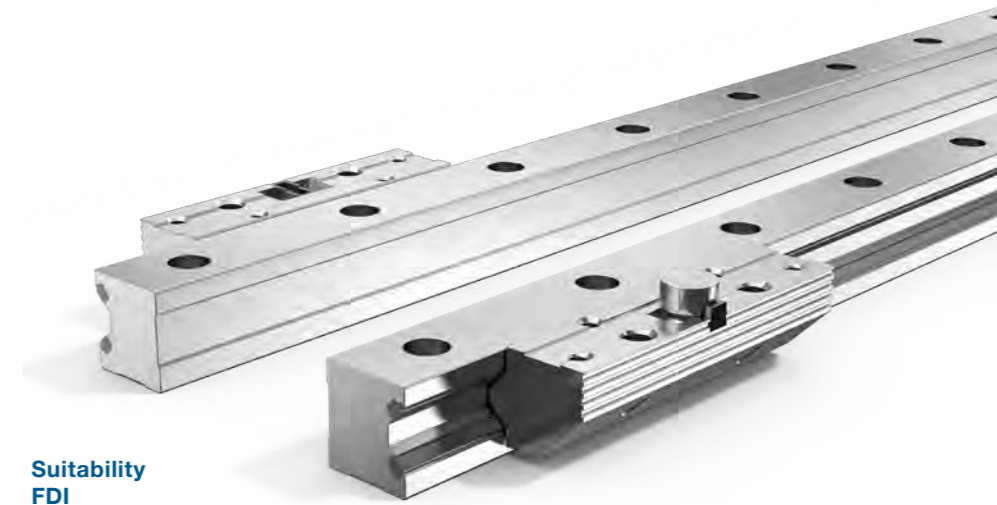
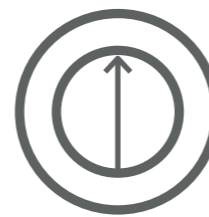

At a glance

Vacuum Class	hPa (mbar)	Suitability FDI
Normal pressure	1013,25	•
Low vacuum	300...1	•
Fine vacuum	1...10 ⁻³	•
High vacuum (HV)	10 ⁻³ ...10 ⁻⁷	•
Ultra high vacuum (UHV)	10 ⁻⁷ ...10 ⁻¹²	on request
Extreme vacuum (XHV)	< 10 ⁻¹²	-
Ideal vacuum (IV)	0	-

Also available as pair of single rails with pair of roller shoes for individual design of the guide width

Suitable for High Vacuum
Franke Aluminum Roller Guides Type FDI are special guides, suitable for use in high vacuum. Cassettes and roller shoes are equipped with vacuum-compatible needle bearings and consist almost entirely of lightweight aluminum.

Details such as fully needed roller bearings as well as special materials and lubricants prevent outgassing in a vacuum.

The guide rails can be manufactured in a length from 200 mm to 4000 mm.

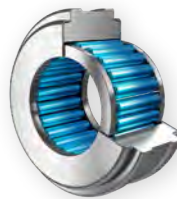

	Standard needle bearing FDA-K	Low-Cost needle bearing FDB-K	Non-magnetic needle bearing FDD-K	Lubricant-free ball bearing FDE-K	Stainless steel, Low-Cost ball bearing FDG-K	Highly dynamic angular contact ball bearing FDH-K	Vacuum-compatible needle bearing FDI-K
Load capacity	•••••	••	•	•	••	•••••	••
Dynamics	•••••	•••	••	•	•••	•••••	••
Corrosion resistance	••	••	•••••	•	•••••	••	•••••
Non-magnetic	•	•	•••••	•	•	•	•
Lubricant-free	•	•	•	•••••	•	•	•
Price	•••••	•••••	•	•	•••	••	••

Still growing: The range of linear guides has been extended by the type FDI.



Sylvia Birzele // Linear System Manufacturing



03

Innovation in Manufacturing

We are masters of our trade. From the **feeler gauge** to the **machining center**. Welcome to the diversity of wire race bearing production.

The High Tech Tinkerers

Between Manual Work and Digitization



The technical possibilities for manufacturing products have never been more diverse than today. Modern materials and manufacturing methods offer an almost inexhaustible pool of production possibilities. The secret lies in finding the right mix between manual work and automation. And to form a team that feels at home in both worlds.

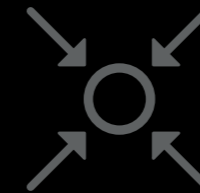

In the production of wire race bearings, the balancing act between manufacture and high-tech becomes clear. Steel wire races, which serve as raceways for balls and rollers, are the heart of every Franke bearing. They are manufactured according to traditional methods and require a maximum of experience and skill.

The situation is different with the housing rings of the bearings. They are manufactured on modern, programmable processing machines and are produced both individually and in large

series. Spatial thinking, solid training as a skilled worker and state-of-the-art machinery are the key requirements here.

As part of the digitization process, monitors were introduced at the workstations. They allow drawing data to be compared with machine parameters or individual process steps to be called up.

The terminals also provide access to the Franke Wiki, the internal knowledge database.

It is one of 8 projects for digitization in the company, which we started and implemented in 2019:

- Paperless processes
- Franke WIKI Database
- Online applications
- Further education management
- Franke Messenger
- Marketing Automation
- Franke Sales App for the field service
- Networking of machines (IoT)

The demands on modern industrial companies in global competition will continue to increase. To be open to new trends while preserving traditions is our key to success and makes it possible to offer you excellent products and the best customer service.



Michael Jung // Wire Race Bearing Manufacturing

90% lighter



At a glance

Lightweight Bearings

Number of bearings/year	10.000 pieces
Common lot sizes	1 - 1000 pieces
Standard/Special solutions	10 / 90 %

Material Housing Parts

Steel	50 % (tendency ↘)
Aluminum	40 % (tendency ↗)
Cast/bronze/plastic/carbon	8 %
3D-Printed	2 % (tendency ↗)

Super Individual: You choose the Material of your bearing 3D printing - 90% lighter and highly variable

One of the most promising technologies in the field of lightweight construction is 3D printing. This process, in which objects are built up layer by layer from individual particles, opens up completely new possibilities in design.

- 90 % lighter than steel
- Honeycomb structure = light & resilient
- Variable wall thicknesses possible
- Material properties variable
- Quickly available from lot size 1
- No accompanying tool costs

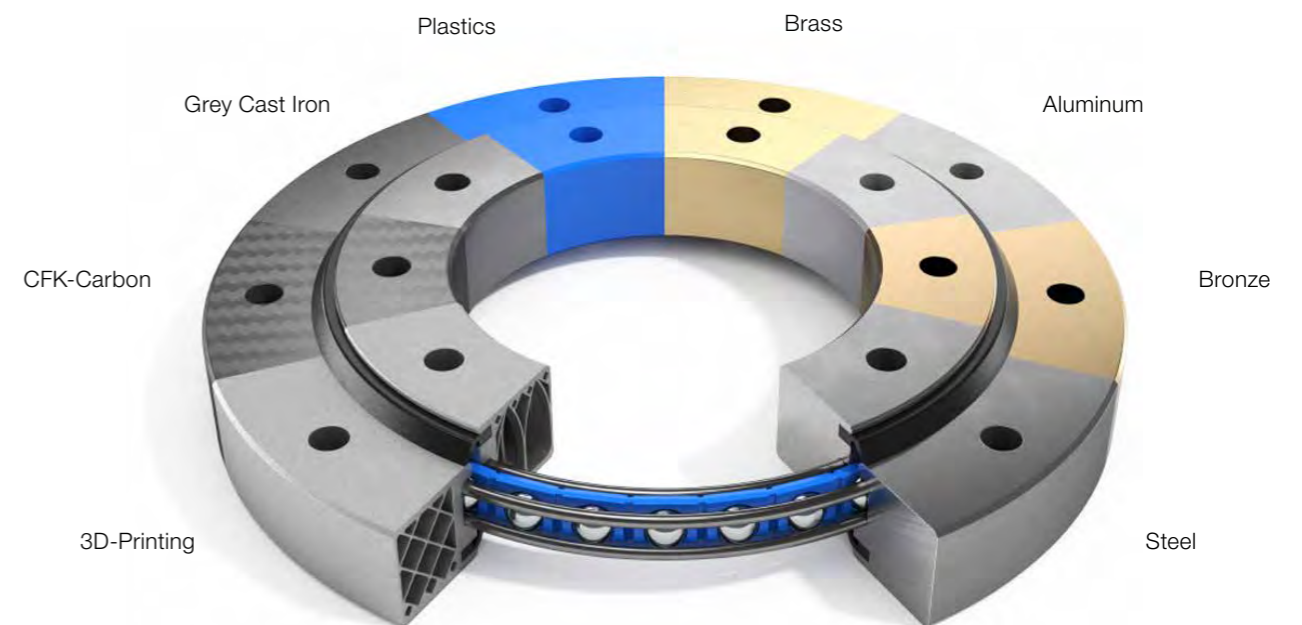

3D printing experts at Franke:
Marian Mutschler and Tamara Preis
Development Engineers, Franke Technikum

Innovation & Competence

For aluminum 3D printing, we work closely with specialists in this technology. 3D printing using plastics we do by ourselves. Plastic printing is used in fixture construction, product development and the manufacture of special components, e.g. roller cages for LVG type bearing assemblies. These are 2-row angular contact roller bearings made of aluminium. They are suitable for the highest load ratings and convince by high rigidity, low rotational resistance and low weight. The roller cages are 3D-printed in segments.





Innovation in Applications

Surprise us with your applications!
We will inspire you with the **various possibilities** to adapt our products to your needs.

04

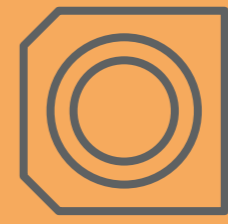

Mounting Head for Circuit Boards

Lightweight - Dynamic - Special



Mounting Head for Circuit Boards

Semiconductor-assembled circuit boards are the heart of all electronic devices. Without them, the kitchen stays cold, the refrigerator gets warm, no drill turns and no cell phone rings. Look around: wherever you discover a modern electronic device, it is highly likely that a Franke special bearing was involved in the production of the circuit boards.

And this bearing has a lot to offer: the Franke special bearing assembly for placement heads is made of special aluminum (dispal). It has almost the same coefficient of thermal expansion as steel and enables constant setting values regarding rotational resistance and preload over the entire temperature range.

This resulted in a customized design that meets all requirements regarding dimensions, material and connection dimensions. The integrated bearing element has a small cross section and enables the customer to achieve a compact, light but nevertheless rigid design. Franke is the only manufacturer worldwide that can meet such requirements.

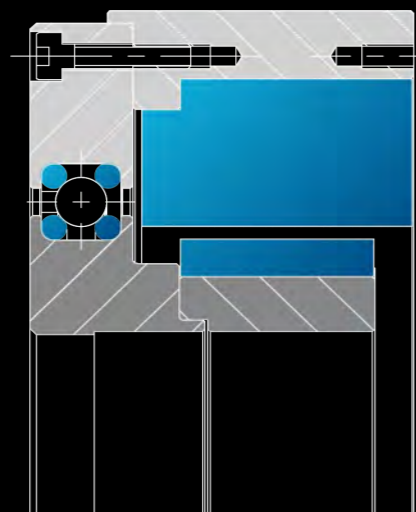

Special bearing with torque-motor

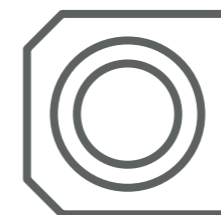
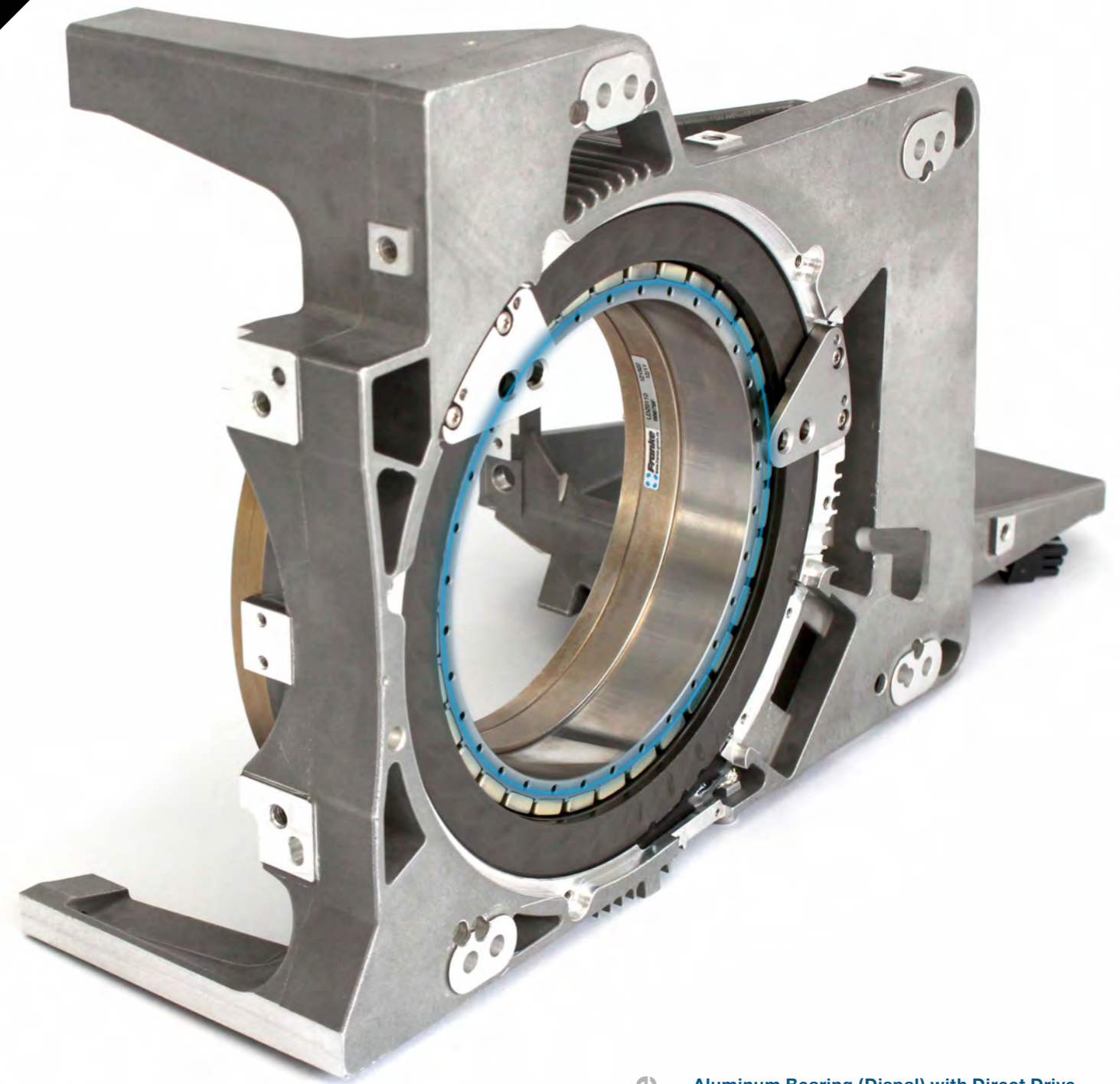

At a glance

Aluminum Bearing (Dispal) with Direct Drive

- Set free of play for temperatures up to 70°C
- Uniform rotational resistance at any temperature
- 18 Start/Stop movements per second
- 120 Million rotations within 5 years
- Integrated direct drive
- Highly rigid aluminum housing
- Ball ring diameter 120mm



E-Mobility

Bearing for Stator Winding Machines

The further development and spread of electromobility is a future-oriented topic in politics and industry. The operation of electric vehicles ensures a significant reduction in CO₂ emissions when using renewable energy sources. The higher demand for electric vehicles increases the need for electric motors.

Franke Wire Race Bearings make an important contribution to the production of electric motors in winding machines for stators.

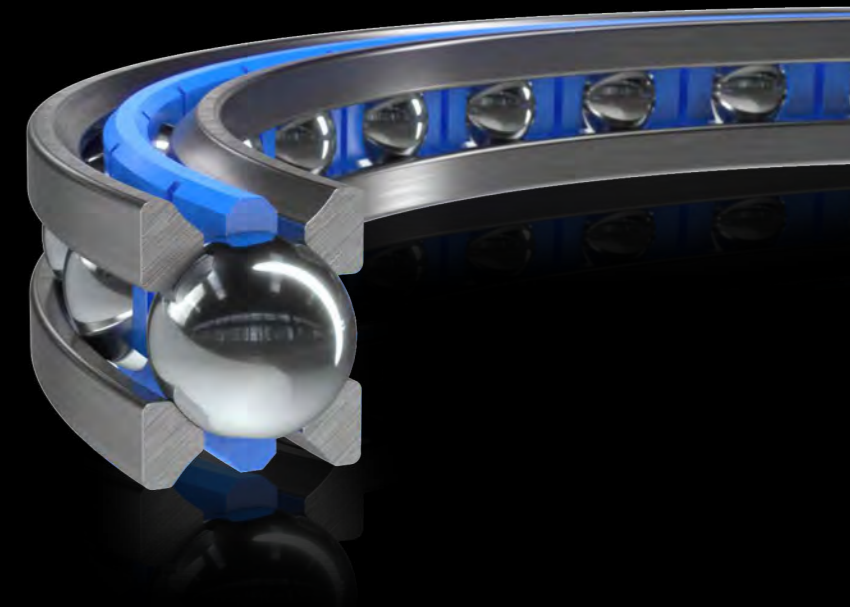

The Task

- Rotary bearing of the winding head
- High accuracy for homogenous windings
- High speed for high throughput
- Lightweight construction to reduce inertia
- High mileage / economy

The Solution

Franke Wire Race Bearings Type LER-3 in diameters from 300 to 700 mm.

The Benefits

- Small installation space
- Integration into existing system
- Numerous diameters available
- Lightweight construction
- Fast availability, partly from stock

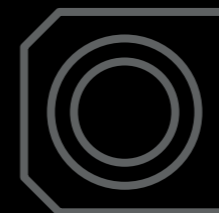



Patents & Awards

Award-winning Innovations

Franke bearings with direct drive for Medical technology received a mention at the INNOVATION AWARD OSTWÜRTTEMBERG. After the EU we now also have patent protection on our invention of a segmented torque motor in the USA and in China.



Franke Bearings Ltd. - England
Social Media Marketing

Charlotte Drake of Franke Bearings Ltd. is an expert for online marketing. In addition to the their website, Franke Bearings Ltd. is active on LinkedIn, Facebook, Twitter and YouTube and posts articles on Franke products and the latest developments at Franke on all channels.



Environment & Energy
Carbon Footprint

Projected at 906 t CO₂ for the year 2020, CO₂ emissions are around 5% below those of the previous year with a simultaneous increase in production output.

The increase in energy efficiency is made possible by years of consistent environmental management based on DIN ISO 14001.



Modern Working World
Mobile Working is Booming

Corona has slowed down a lot of things but also accelerated many things. Mobile working and the increased use of video conferencing are among the winners of the new normality. More than 50 % of the administrative staff worked from home during the pandemic – an option that is now being offered on a permanent basis and very well accepted.



Training at Franke
NEXT Generation

With currently 24 trainees, more young people are learning their profession at Franke at the same time than ever before. This includes new professions such as digital business management, IT specialist or warehouse clerk.

How to stay in touch with Franke



Telephone

We can be reached by phone between 7:30am and 4:00pm during the week.
Tel. +49 7361 920-0



E-Mail

Please send us an e-mail:
info@franke-gmbh.de



Online Meeting

We will gladly arrange an online meeting with you via Skype, Circuit, Google Hangout, ...



Website

The Franke website offers information about our products and the company. You can reach us there via our contact form.



Downloads

On our website you can download our standard program, catalogs, manuals, CAD files and much more.



Newsletter

Subscribe to our newsletter to be informed regularly about our latest developments.



Social Media

Further information about Franke can also be found on our social media channels: YouTube, LinkedIn, Xing and Facebook.

